

Struttura estraibile doppio

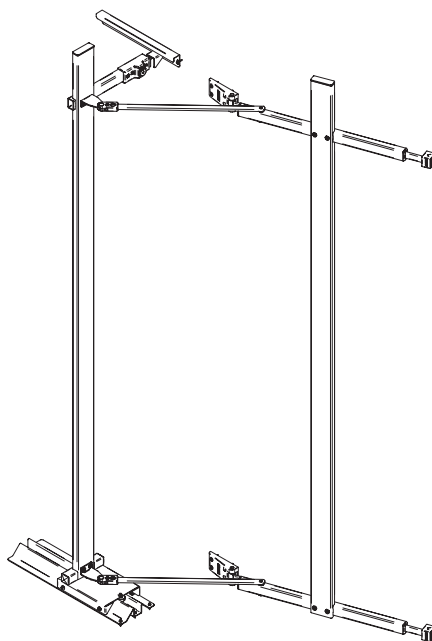

Swing out pantry unit frame

EDS1154/20
EDS1704/20
EDS1156/20
EDS1706/20
EDS1157/20
EDS1707/20



Versione destra
Right hand version
Sx=Dx









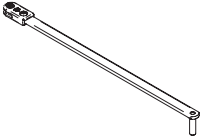
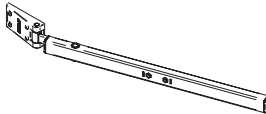
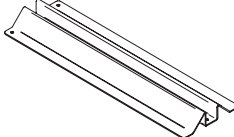
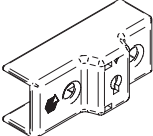

 Max: 78 Kg	 30 min	 x 1
---	--	---

 +	
---	---

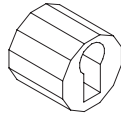
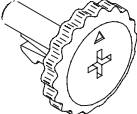
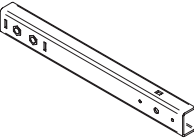
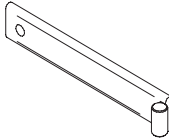
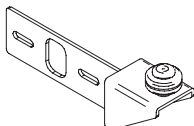
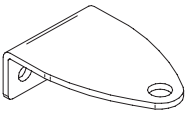
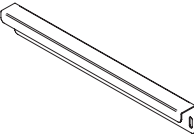
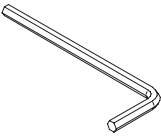
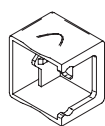
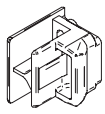
Info

1) AVVERTENZA! Leggi attentamente le istruzioni prima del montaggio e segui ogni passaggio indicato. L'azienda declina ogni responsabilità dall'uso improprio del prodotto. Ogni uso improprio del prodotto può causare lesioni. Modifiche o manomissioni del prodotto, annullano ogni condizione di garanzia.
2) Smaltisci i diversi materiali secondo regolamentazioni della tua città.

1) WARNING! Read the instructions carefully before assembly and follow each step indicated. The company declines all responsibility for improper use of the product. Any improper use of the product can cause injury. Modifications or tampering with the product void any warranty conditions.
2) Proceed to dispose of the different materials according to your city regulations.

A  x1	B  x1	C  x2	D  x2	E  x1							
F  x1	G  x2	H  x1	J  x1	K  x1	L  x2						
M  x1	N  x1	Q  x1	Y  x1	P  x2	R  x2	S  x8 Ø5X20	T  x2 M5X10	U  x2	V  x11 Ø4X16	W  x6 M6X25	X  x2

1 Sx=Dx

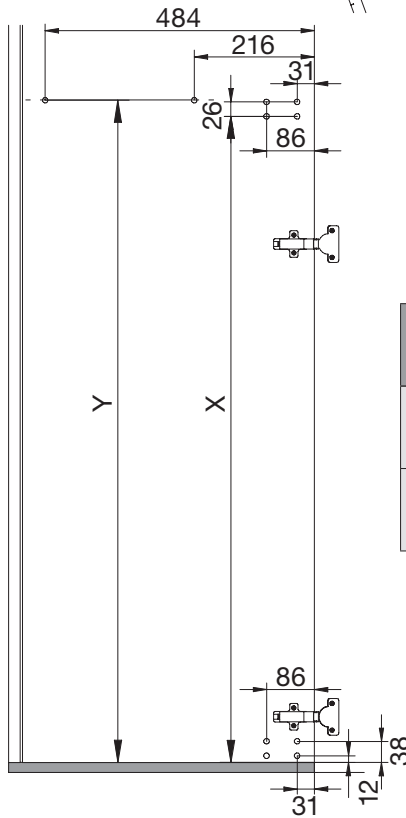
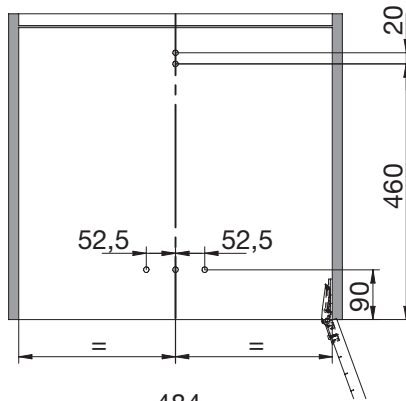
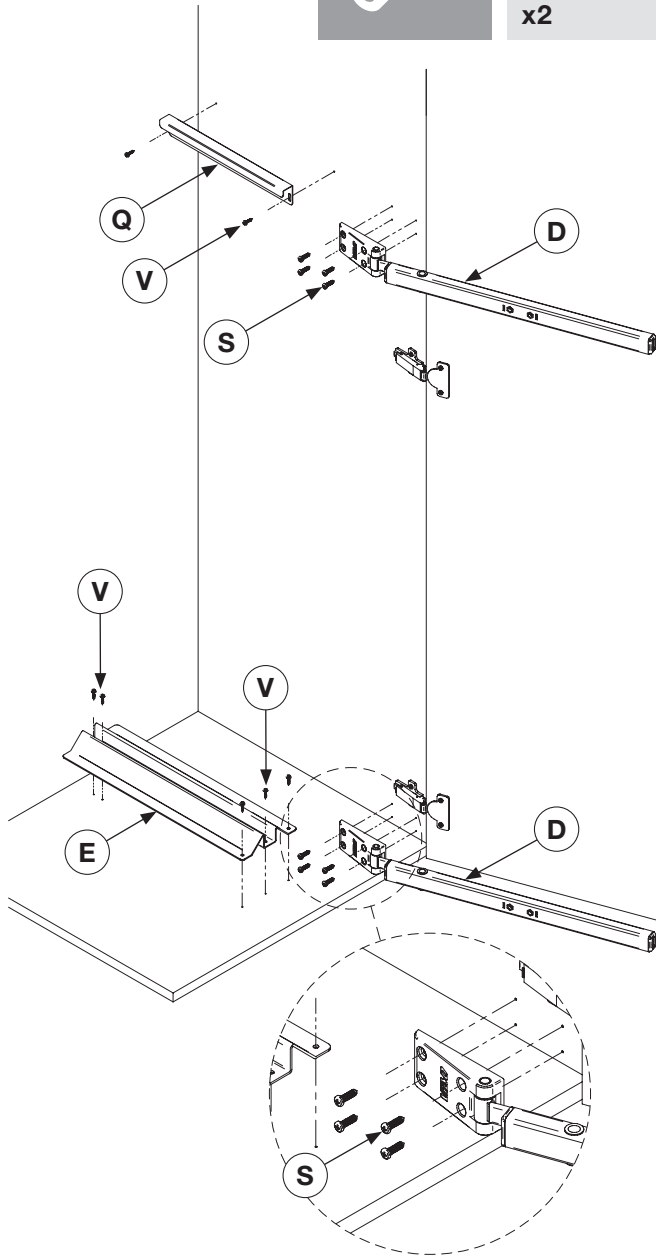
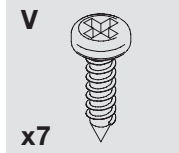
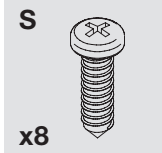
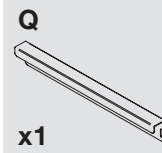
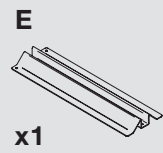
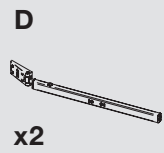

Mod	Y	X
EDS115	973	944
EDS170	1523	1494

Versione destra
Right hand version

2

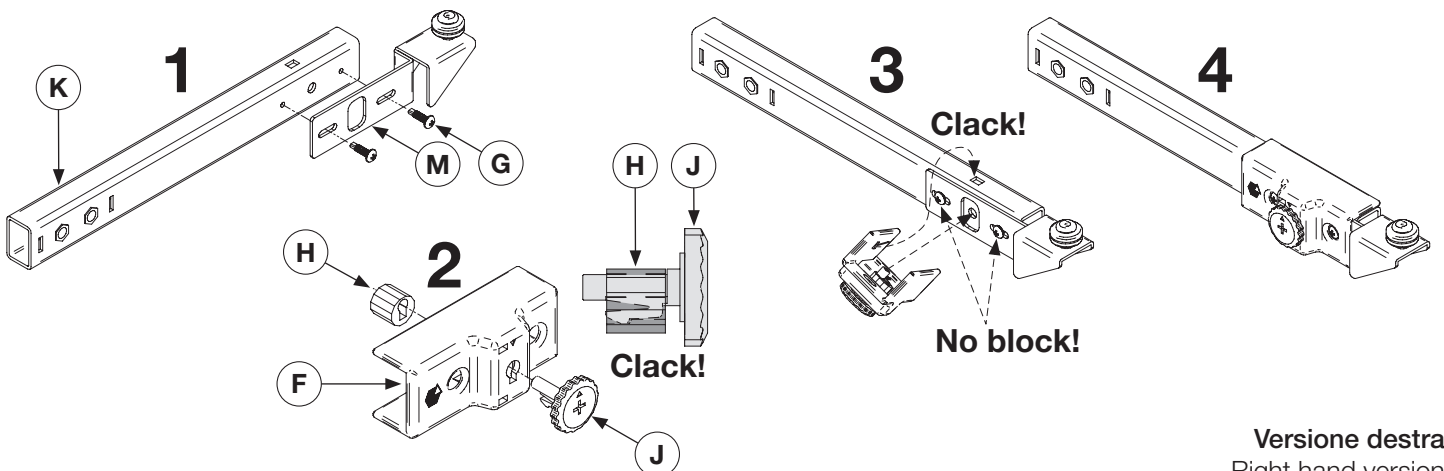
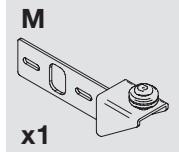
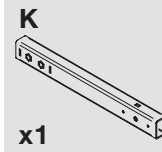
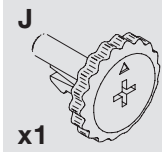
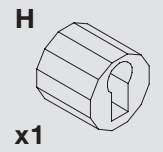
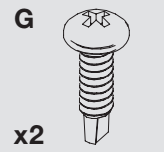
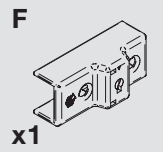

Versione destra
Right hand version

3

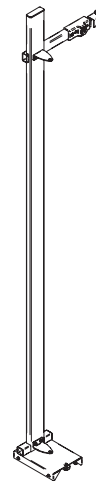
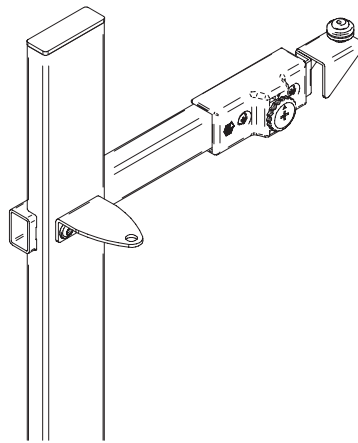
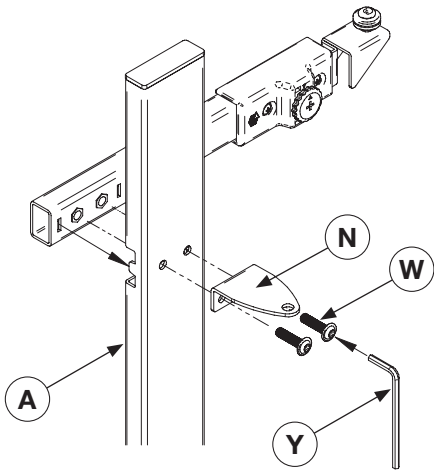
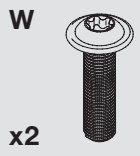
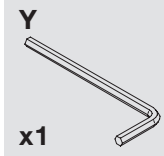
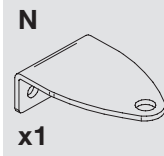
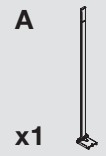

Versione destra
Right hand version

4

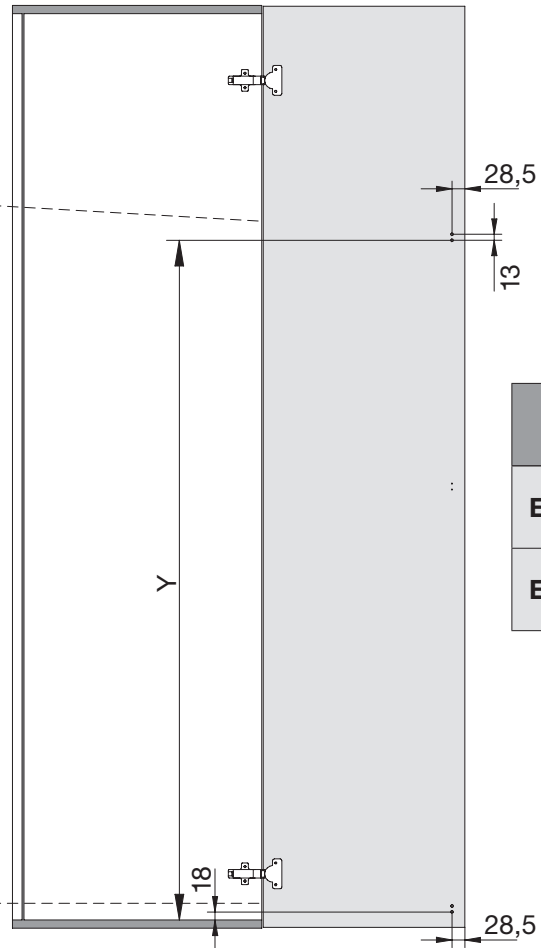
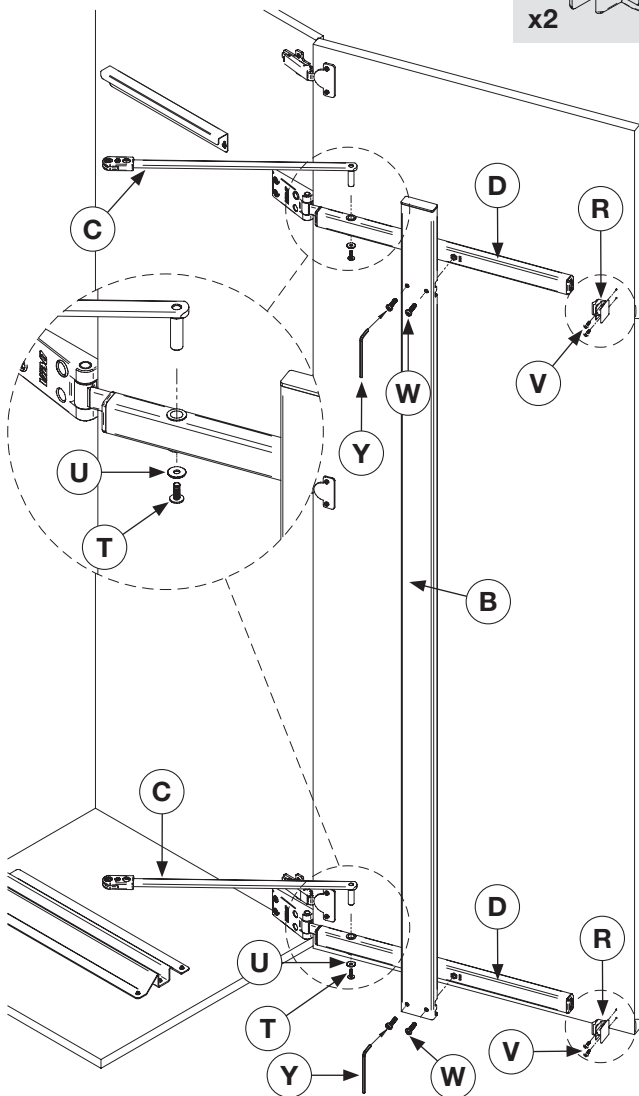
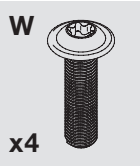
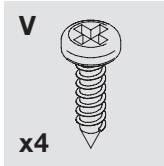
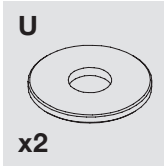
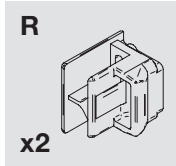
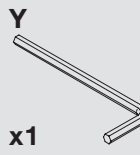
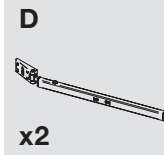
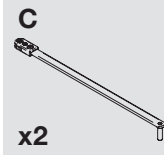

Mod	Y
EDS115	950
EDS170	1500

Versione destra
Right hand version

5

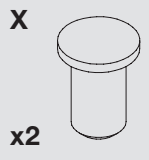
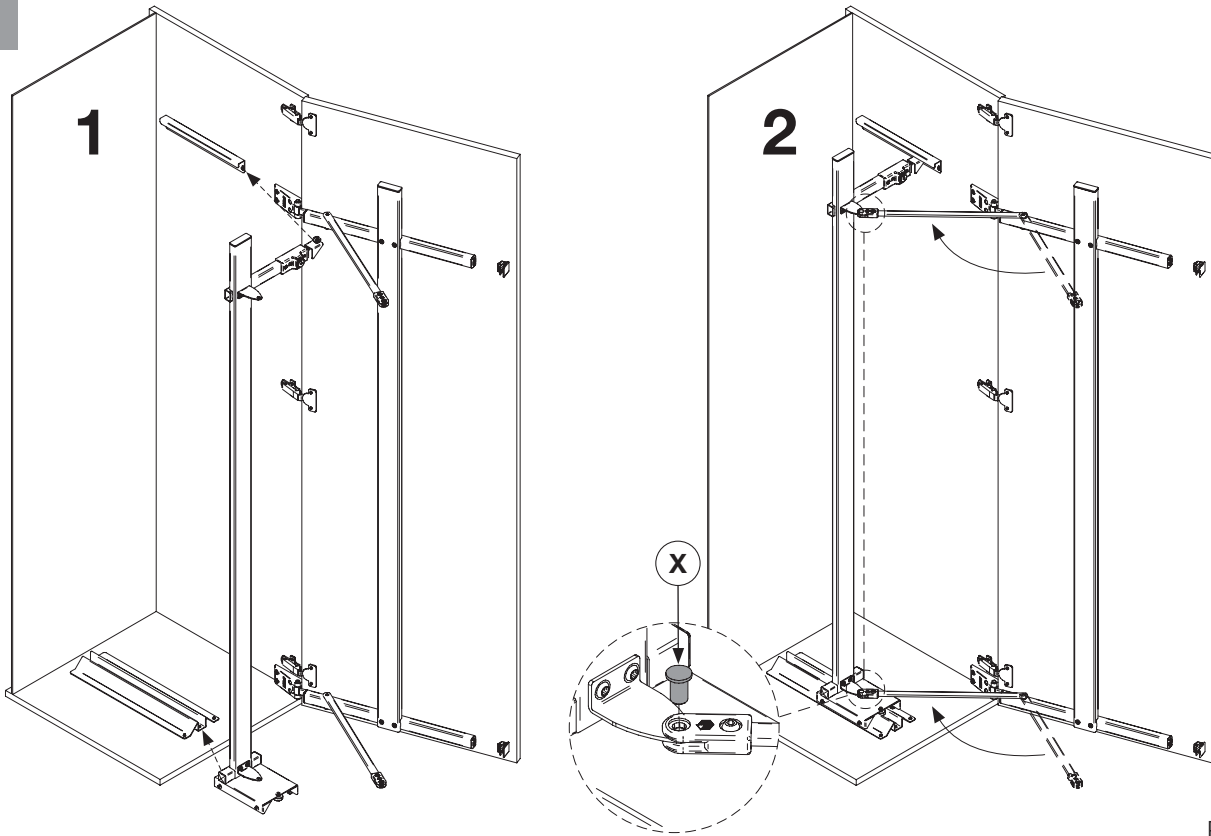

Versione destra
Right hand version

6

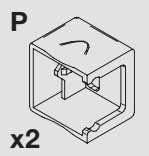
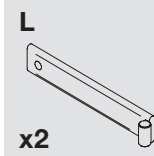
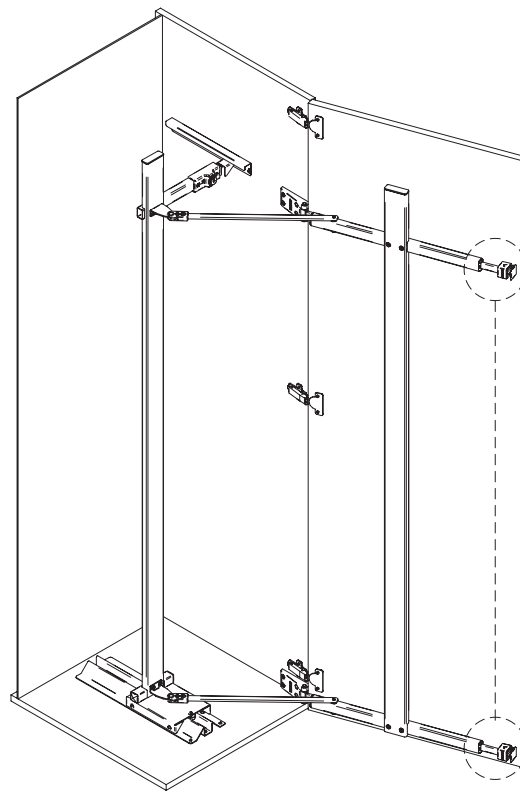
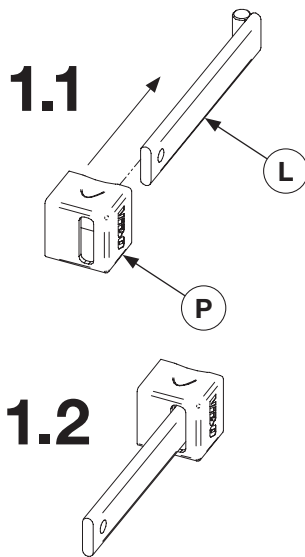

2.1

2.2

2.3

2.4

Versione destra
Right hand version

Vibo spa
 via Arzignano, 46
 36070 Trissino (VI) Italy
 T +39 0445-492800
 F +39 0445-492999
 vibo@viboitaly.com
 www.viboitaly.com