

SpaceLock pantry storage

Dispensa SpaceLock

SpaceLock | SpaceLock

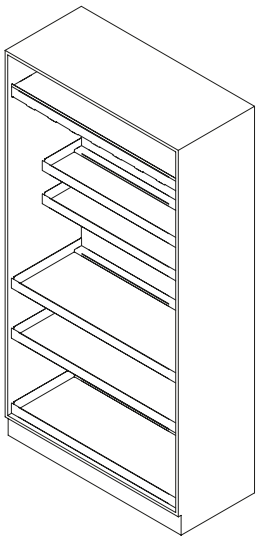

Mod. 60 F18
Mod. 60 F19
Mod. 75 F18
Mod. 75 F19
Mod. 90 F18
Mod. 90 F19
Mod. 120 F18
Mod. 120 F19

Warnings

1. Leggi attentamente le istruzioni prima del montaggio e segui ogni passaggio indicato. L'azienda declina ogni responsabilità nel caso di mancato rispetto delle indicazioni riportate sulle istruzioni montaggio. L'azienda declina ogni responsabilità per l'uso improprio del prodotto.
 2. Questo prodotto NON è una scala. Ogni uso improprio del prodotto può causare lesioni. Modifiche o manomissioni del prodotto, annullano ogni condizione di garanzia.
 3. Questo prodotto contiene piccole parti. Rischio di soffocamento. Tenere fuori dalla portata dei bambini. In caso di malfunzionamento, interrompere l'uso e contattare l'Assistenza Tecnica autorizzata.
 4. Smaltisci i diversi materiali secondo le regolamentazioni della tua città.
1. Please read the instructions carefully before assembly and follow each step indicated. The company declines all responsibility in case of non-compliance with the instructions provided for assembly. The company is not responsible for improper use of the product.
 2. This product is NOT a ladder. Any improper use of the product may cause injury. Modifications or tampering with the product voids any warranty conditions.
 3. This product contains small parts. Choking hazard. Keep out of reach of children. In case of malfunction, stop using the product and contact authorized Technical Support.
 4. Proceed to dispose of the different materials according to your city regulations.

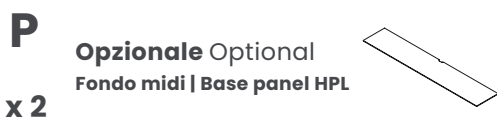
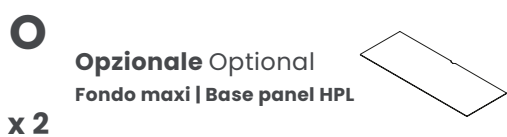
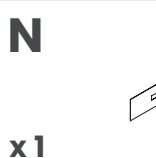
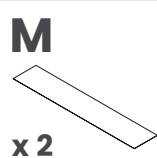
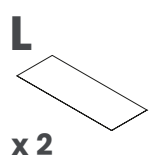
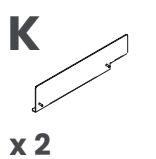
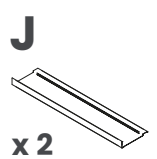
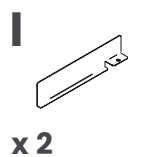
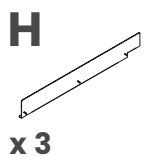
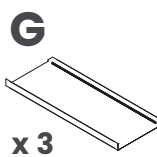
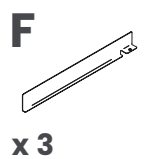
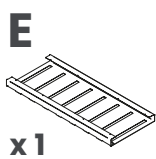
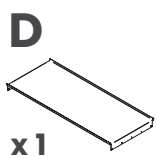
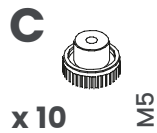

Attention!

1. Rinforcare il fondo del mobile con un piedino aggiuntivo se necessario.
2. Verificare la messa in bolla del mobile.
3. Fissare il mobile a parete.

1. The bottom of the cabinet could be reinforced with additional legs if necessary.
2. The levelling of the cabinet must be verified.
3. The cabinet must be fixed to the wall.

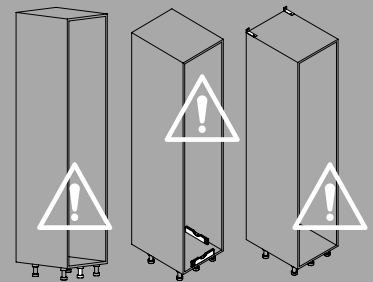

Maintenance and disposal

Il corretto smaltimento dell'imballaggio e la manutenzione del prodotto sono importanti per noi. Scansiona il codice QR per maggiori informazioni

Proper packaging disposal and product maintenance are important to us. Scan the QR code for more information



Technical data sheet

Scansiona il codice QR della pagina prodotto per visionare la relativa scheda tecnica

Scan the QR code of the product page of the website to view the technical data sheet



ripiano fisso midi
medium fixed shelf



ripiano fisso maxi
maxi fixed shelf

1.

portacalici da 4 calici per vano
wine glass holder for 4 wine glasses per compartment

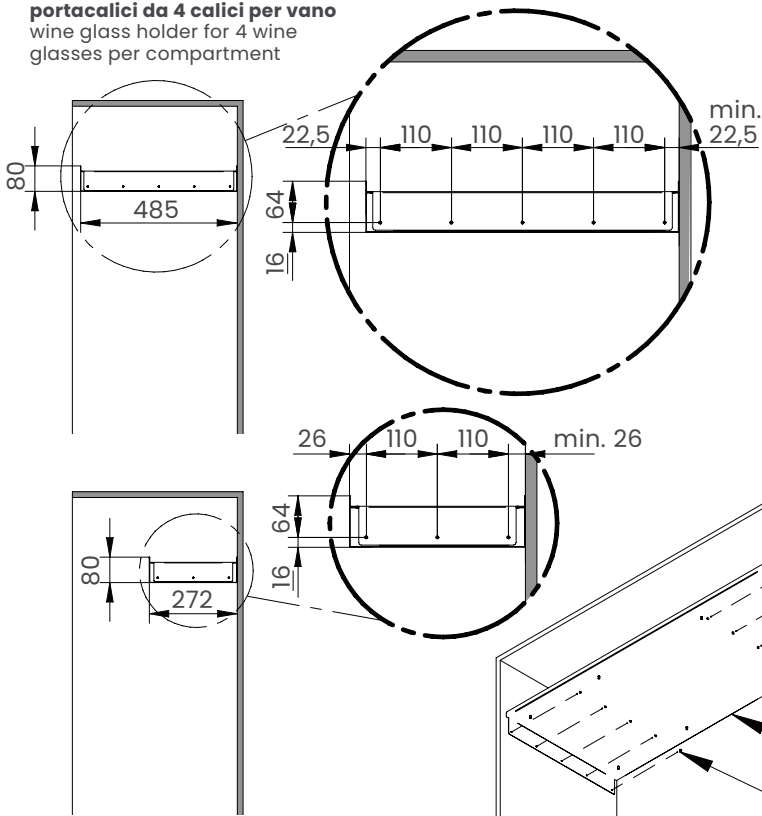

portacalici da 2 calici per vano
wine glass holder for 2 wine glasses per compartment

2.

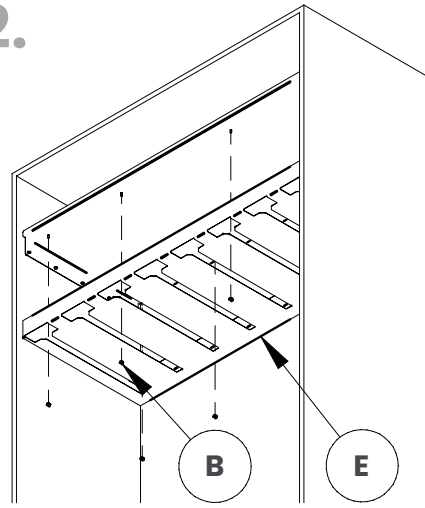

M5

B



x 8

E



x 1

A



x 10



+

D



x 1

3. **Schema di foratura** Hole pattern

fori diametro 3 mm, profondità 9 mm | holes diameter 3 mm, depth 9 mm

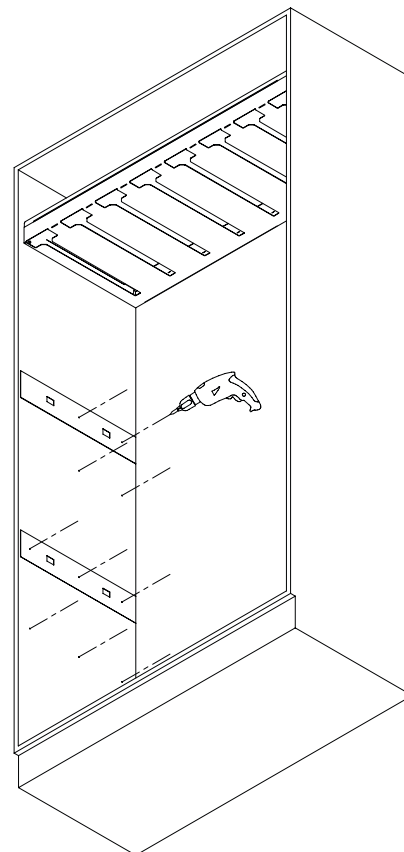
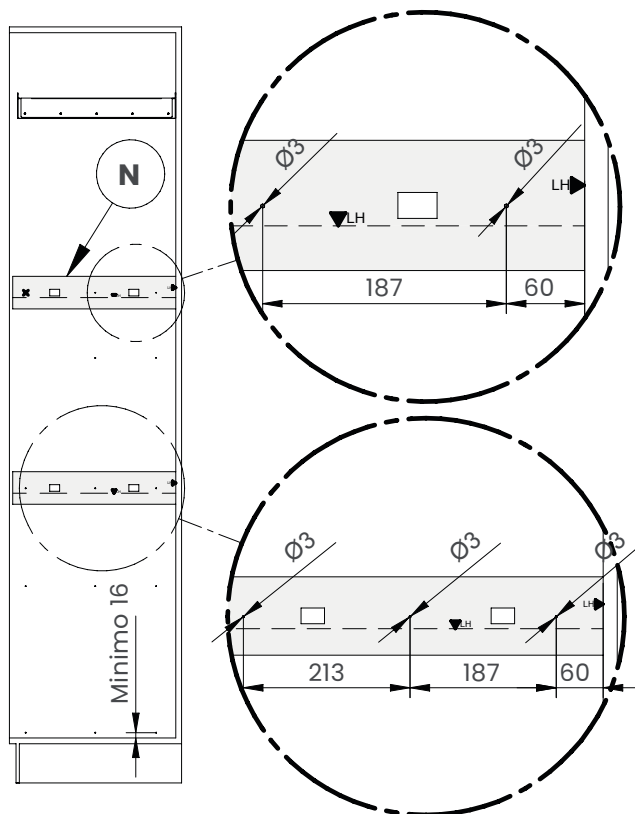

N



x 1

4.

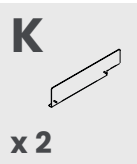
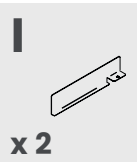
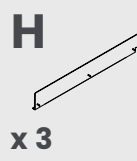
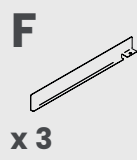
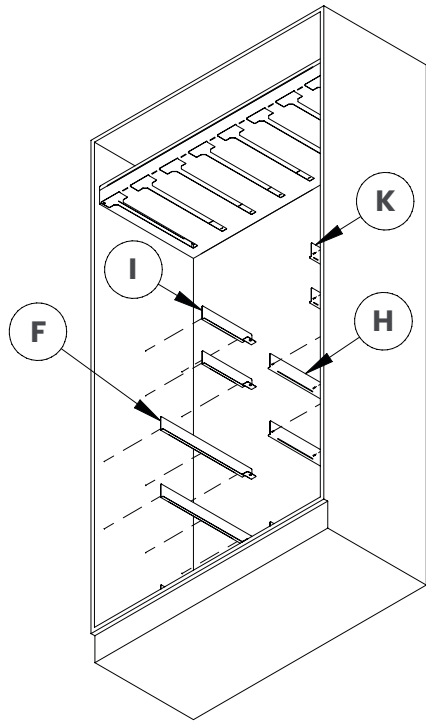

5.

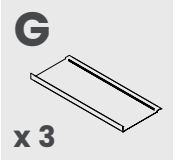
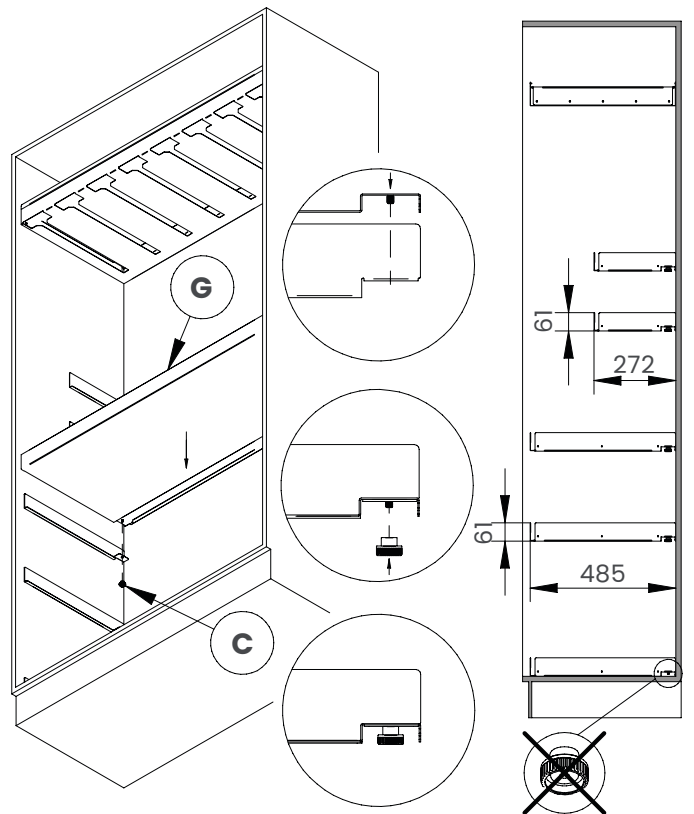

6.

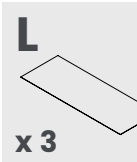
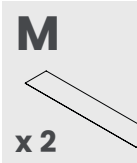
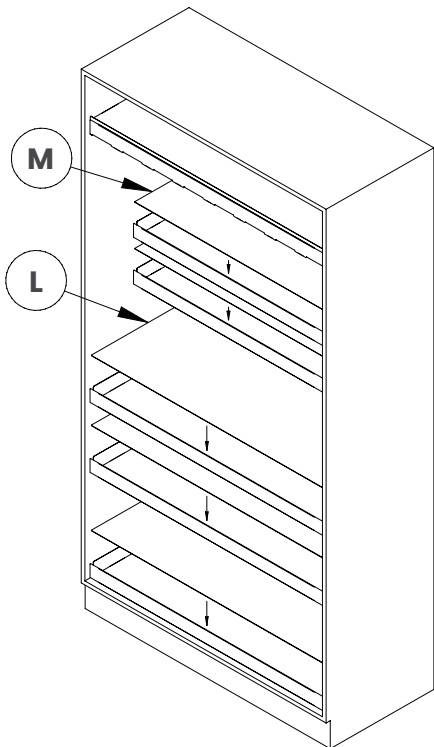

7.

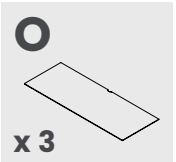
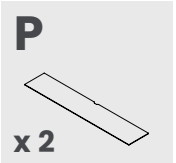
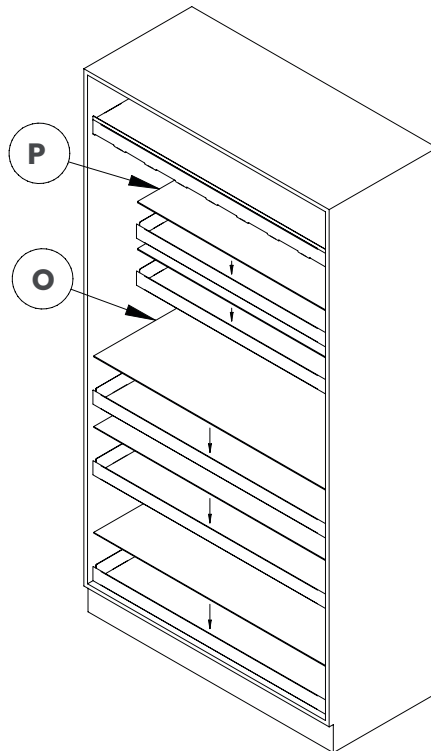

Fondi opzionali Optional base panels

8.

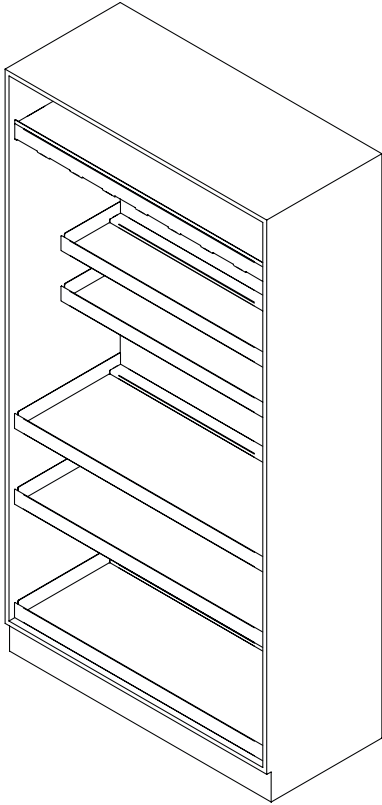

9.

