

Wire manual larder unit with pivoting slide

Colonna manuale con guida rotante Wire

Colonne | Larder units

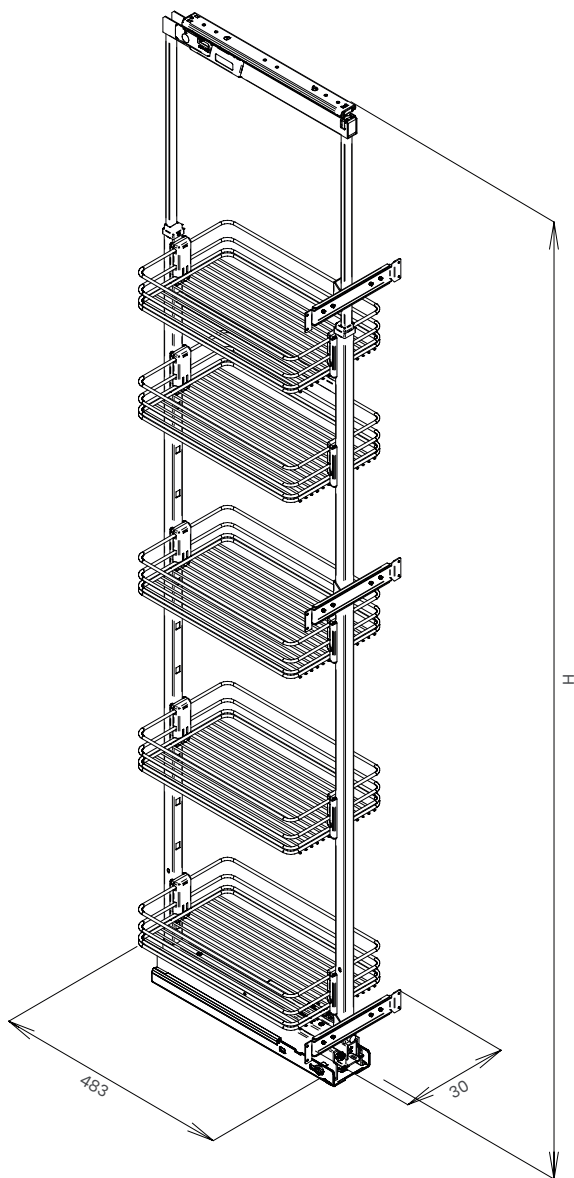

Cat. code

Structure

CE1204

C Nome Name
E Estraibile Pulling-out
120 Dimensione Dimension
4 Versione Version

Basket

CC15AS10

CC Nome Name
15 Modulo Cabinet size
AS Attacco a scatto Snap
10 Edizione Year

Door bracket kit

CK115N

C Per colonna
For larder unit
K Kit Kit
115 Modulo Cabinet size
N Nuova versione
New version

Pivoting slide

GCFTMR

GC Guida Slide
FT Marchio guida
Slide's brand
MR Ammortizzato
Dampened soft-closed

Instruction sheet

Structure

ND*

Baskets

4004112890MKT

Door bracket kit

4004114770MKT

Pivoting slide

4004111620MKT

Description

Telaio colonna regolabile in altezza completo di guida rotante ad estrazione totale con rientro ammortizzato. Portata 100 kg. Cesto per colonna in filo. L'aggancio ed il bloccaggio a scatto avvengono inserendo il cesto in prossimità dei fori del telaio colonna. Kit composto da 1 staffa per fissaggio e regolazione dell'anta e relativa ferramenta. Applicazione rapida negli stessi fori interni del telaio.

Height-adjustable frame for manual larder unit complete with a total extension pivoting slide with dampened soft-closing system. Load capacity 100 kg. Wire basket for larder unit with snap fastening, which works by placing the basket on the frame's holes. Kit consisting of 1 fixing and adjustable door bracket and fittings. Quick installation on the same internal holes of the frame.

Finish







VG | VG Mechanism
Grigio Antracite
Verniciato grigio
 Light grey

C Baskets
Cromo
 Chromed-plated

Dimensions

Frame	Cabinet size (cm)	Width (mm)	Depth (mm)	Height (mm)
CE1204	15	30	484	993-1293
CE1604	30	30	484	1393-1693
CE1904	40	30	484	1693-1993
Baskets	Cabinet size (cm)	Width (mm)	Depth (mm)	Height (mm)
CC15AS10	15	96	434	92
CC30AS10	30	246	434	92
CC40AS10	40	346	434	92
CC45AS10	45	396	434	92
CC50AS10	50	446	434	92
CC60AS10	60	546	434	92
Door brackets	Cabinet size (cm)	Width (mm)	Depth (mm)	Height (mm)
CK115N	15	100	40	53
CK130N	30	250	40	45
CK140N	40	350	40	45
CK145N	45	400	40	45
CK150N	50	450	40	45
CK160N	60	550	40	45
Pivoting slide	Cabinet size (cm)	Width (mm)	Depth (mm)	Height (mm)
GCFTMR	—	—	500	250

Load capacity Kg

	Portata telaio Frame capacity
	Portata cesto 15 Basket capacity 15
	Portata cesto 30 Basket capacity 30
	Portata cesto 40 Basket capacity 40
	Portata cesto 45 Basket capacity 45
	Portata cesto 50 Basket capacity 50
	Portata cesto 60 Basket capacity 60

Packaging

Frame	Size (cm)	Weight (mm)
CE1204		
CE1604		
CE1904		
Baskets	Size (cm)	Weight (mm)
CC15AS10		
CC30AS10		
CC40AS10		
CC45AS10		
CC50AS10		
CC60AS10		
Door brackets	Size (cm)	Weight (mm)
CK115N		
CK130N		
CK140N		
CK145N		
CK150N		
CK160N		
Pivoting slide	Size (cm)	Weight (mm)
GCFTMR		

Pallet configuration

Size (mm)	Pieces
1200 x 800	13
1200 x 800	13
1200 x 800	13
1200 x 800	140
1200 x 800	102
1200 x 800	95
1200 x 800	95
1200 x 800	60
1200 x 800	60
1200 x 800	ND*
1200 x 800	ND*
1200 x 800	ND*
1200 x 800	ND*
1200 x 800	ND*
1200 x 800	ND*
1200 x 800	ND*
1200 x 800	ND*

Maintenance

Inquadrate il codice QR per scoprire il modo corretto di smaltire l'imballaggio e la corretta manutenzione del prodotto.

Scan the QR code to discover the correct way to dispose the packing and the correct maintenance of the product.



Materials

Metallo Metal
Plastica Plastic

*Non disponibile al momento Not available at the moment



Vibo S.p.A Via Arzignano, 46 36070
Trissino VI - Italy | Tel +39 0445 492800
vibo@viboitaly.com | viboitaly.com

*Le informazioni contenute nelle presenti schede tecniche sono indicative. Eventuali differenze con il listino in vigore non costituiscono motivo di contestazione. The information given in this technical sheet are indicative. Any discrepancies with the price list currently in force cannot be cause for complaint.